

**Programmable High Frequency Crystal Oscillator with Spread Spectrum (SSXO) and No Spread Spectrum (XO) Option**

**Features**

- Crystal Oscillator with Spread Spectrum Clock (SSXO)
- No Spread Spectrum (XO) Option
- Wide operating output clock frequency range of 10 –166 MHz
- Programmable spread spectrum with nominal 31.5 kHz modulation frequency
- Center spread:  $\pm 0.25\%$  to  $\pm 2.0\%$
- Down spread:  $-0.5\%$  to  $-4.0\%$
- No spread:  $\pm 0.0\%$
- Integrated phase-locked loop (PLL)
- 85 ps typical cycle-to-cycle jitter with SSCLK = 133 MHz
- 3.3V operation
- Output enable function
- Package available in 4-Pin ceramic LCC SMD
- Pb-Free package
- Industrial temperature from  $-40^{\circ}\text{C}$  to  $85^{\circ}\text{C}$

**Benefits**

- Provides a wide range of spread percentages for maximum electromagnetic interference (EMI) reduction to meet regulatory agency electromagnetic compliance (EMC) requirements. Reduces development and manufacturing costs and time-to-market.
- This versatile programming feature enables the user to switch between SSXO (with Spread) and XO (without Spread) functions with ease.
- Internal PLL to generate up to 166 MHz output.
- Suitable for most PC, consumer, and networking applications
- Application compatibility in standard and low-power systems
- In house programming of samples and prototype quantities is available using CY3672 programming kit and CY3724 socket adapters. Production quantities are available through Cypress' value added distribution partners or by using third party programmers from BP Microsystems, and HiLo Systems, and others.

**Logic Block Diagram**

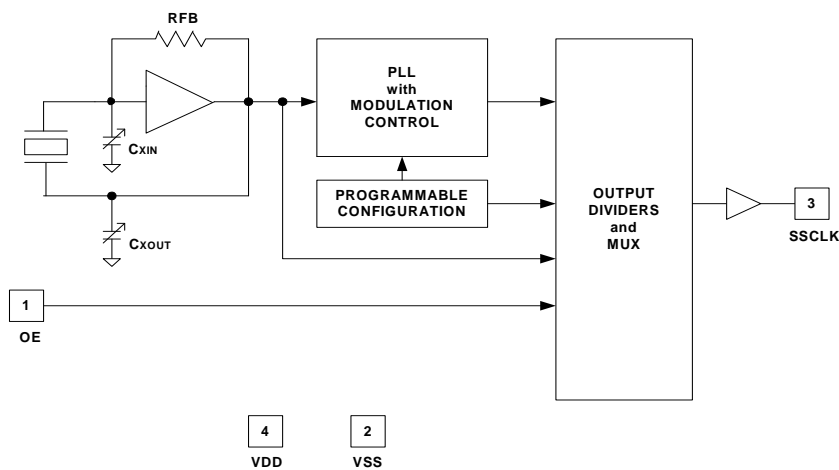

## Pinouts

Figure 1. Pin Diagram - CY25701 4-Pin Ceramic SMD

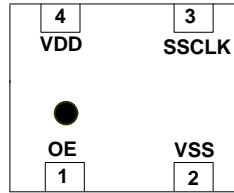

Table 1. Pin Definitions - CY25701 4-Pin Ceramic SMD

Pin	Name	Description
1	OE	Output Enable pin: Active HIGH. If OE = 1, SSCLK is enabled
2	VSS	Power supply ground
3	SSCLK	Spread spectrum clock output (with or without spread)
4	VDD	3.3V power supply

### Functional Description

The CY25701 is a Spread Spectrum Crystal Oscillator (SSXO) IC used to reduce the EMI found in today's high speed digital electronic systems.

The device uses a Cypress proprietary PLL and Spread Spectrum Clock (SSC) technology to synthesize and modulate the frequency of the embedded input crystal. By frequency modulating the clock, the measured EMI at the fundamental and harmonic frequencies are greatly reduced. This reduction in radiated energy can significantly reduce the cost of complying with regulatory agency (EMC) requirements and improve time-to-market without degrading system performance.

The CY25701 uses a programmable configuration memory array to synthesize output frequency and spread%.

The spread percentage is programmed to either center spread or down spread with various spread percentages. The range for center spread is from  $\pm 0.25\%$  to  $\pm 2.00\%$ . The range for down spread is from  $-0.5\%$  to  $-4.0\%$ . Contact the factory for smaller or larger spread percentage amounts if required. Refer to [Table 3 on page 3](#) for spread selection and no spread values.

The frequency modulated SSCLK output is programmable from 10 to 166 MHz.

The CY25701 is available in a 4-pin ceramic SMD package with an operating temperature range of  $-40$  to  $85^{\circ}\text{C}$ .

### Programming Description

#### Factory and Field Programmable CY25701

Factory and field programming is available for samples and manufacturing by Cypress and its distributors. Submit your request to the local Cypress Field Application Engineer (FAE) or sales representative. Once the request is processed, you will receive a new part number, samples, and data sheet with the programmed values. This part number is used for additional sample request and the production orders. Contact your local Cypress FAE or sales representative for details.

Additional information on the CY25701 is available at the Cypress web site [www.cypress.com](http://www.cypress.com).

#### Output Frequency, SSCLK Output (SSCLK, pin 3)

The modulated frequency at the SSCLK output is produced by synthesizing from the embedded crystal oscillator frequency input. The range of synthesized clock is from 10 to 166 MHz.

#### Spread Percentage (SSCLK, pin 3)

The SSCLK spread is programmable to various spread percentage values from  $\pm 0.25\%$  to  $\pm 2.0\%$  for center spread and from  $-0.5\%$  to  $-4.0\%$  for down spread. Refer to [Table 3 on page 3](#) for available spread options. Enter  $\pm 0.0\%$  (No spread) for XO (crystal oscillator) without spread option.

#### Frequency Modulation (SSCLK, pin 3)

The default frequency modulation is programmed at 31.5 kHz for all SSCLK frequencies from 10 to 166 MHz. Alternate frequency modulations at 30.1 kHz or 32.9 kHz are selectable using CyberClocksOnline™ software. Contact the factory for other alternate modulation frequencies if required.

**Table 2. Programming Data Requirement**

Pin Function	Output Frequency	Spread Percent Code <sup>[1]</sup>	Frequency Modulation
Pin Name	SSCLK	SSCLK	SSCLK
Pin#	3	3	3
Units	MHz	%	kHz
<b>Program Value</b>	<b>ENTER DATA</b>	<b>ENTER DATA</b>	<b>ENTER DATA 31.5</b>

**Table 3. Spread Percent Selection**

Center Spread	Code	A	B	C	D	E	F	Z
	Percentage	±0.25%	±0.5%	±0.75%	±1.0%	±1.5%	±2.0%	±0.0%
Down Spread	Code	G	H	J	K	L	M	Z
	Percentage	-0.5%	-1.0%	-1.5%	-2.0%	-3.0%	-4.0%	±0.0%

**Absolute Maximum Ratings**

Supply Voltage (VDD).....	-0.5V to +7.0V	Junction Temperature .....	-40°C to +125°C
DC Input Voltage .....	-0.5V to V <sub>DD</sub> + 0.5V	Data Retention at T <sub>j</sub> = 125°C .....	>10 years
Storage Temperature (Non-condensing) ....	-55°C to +100°C	Package Power Dissipation.....	350 mW

**Operating Conditions**

Parameter	Description	Min	Typ	Max	Unit
V <sub>DD</sub>	Supply voltage	3.00	3.30	3.60	V
T <sub>A</sub>	Ambient temperature (commercial)	-20	-	70	°C
T <sub>A</sub>	Ambient temperature (industrial)	-40	-	85	°C
C <sub>LOAD</sub>	Max. load capacitance at pin 3	-	-	15	pF
F <sub>SSCLK</sub>	SSCLK output frequency, C <sub>LOAD</sub> = 15 pF	10	-	166	MHz
F <sub>MOD</sub>	Spread Spectrum Modulation Frequency	30.0	31.5	33.0	kHz
T <sub>PU</sub>	Power up time for VDD to reach minimum specified voltage (power ramp must be monotonic)	0.05	-	500	ms

**DC Electrical Characteristics**

Parameter	Description	Condition	Min	Typ	Max	Unit
I <sub>OH</sub>	Output high current (pin 3)	V <sub>OH</sub> = V <sub>DD</sub> - 0.5, V <sub>DD</sub> = 3.3V (source)	10	12	-	mA
I <sub>OL</sub>	Output low current (pin 3)	V <sub>OL</sub> = 0.5, V <sub>DD</sub> = 3.3V (sink)	10	12	-	mA
V <sub>IH</sub>	Input high voltage (pin 1)	CMOS levels, 70% of V <sub>DD</sub>	0.7V <sub>DD</sub>	-	V <sub>DD</sub>	V
V <sub>IL</sub>	Input low voltage (pin 1)	CMOS levels, 30% of V <sub>DD</sub>	-	-	0.3V <sub>DD</sub>	V
I <sub>IH</sub>	Input high current (pin 1)	V <sub>in</sub> = V <sub>DD</sub>	-	-	10	µA
I <sub>IL</sub>	Input low current (pin 1)	V <sub>in</sub> = V <sub>SS</sub>	-	-	10	µA
I <sub>OZ</sub>	Output leakage current (pin 3)	Three-state output, OE = 0	-10	-	10	µA
C <sub>IN</sub> <sup>[2]</sup>	Input capacitance (pin 1)	Pin 1, or OE	-	5	7	pF
I <sub>VDD</sub>	Supply current	V <sub>DD</sub> = 3.3V, SSCLK = 10 to 166 MHz, C <sub>LOAD</sub> = 0, OE = V <sub>DD</sub>	-	-	50	mA
Δf/f	Initial accuracy at room temp.	T <sub>A</sub> = 25°C, 3.3V	-25	-	25	ppm
	Freq. stability over temp. range	T <sub>A</sub> = -20°C to 70°C, 3.3V	-25	-	25	ppm
	Freq. stability over voltage range	3.0 to 3.6V	-12	-	12	ppm
	Aging	T <sub>A</sub> = 25°C, First year	-5	-	5	ppm

- Notes**
- ±0.0% or Code "Z" for XO (No-Spread) option.
  - Guaranteed by characterization, not fully tested.

## AC Electrical Characteristics<sup>[2]</sup>

Parameter	Description	Condition	Min	Typ	Max	Unit
DC	Output Duty Cycle	SSCLK, Measured at $V_{DD}/2$	45	50	55	%
$t_R$	Output Rise Time	20%–80% of $V_{DD}$ , $C_L = 15$ pF	–	–	2.7	ns
$t_F$	Output Fall Time	20%–80% of $V_{DD}$ , $C_L = 15$ pF	–	–	2.7	ns
$T_{CCJ1}$ <sup>[3]</sup>	Cycle-to-Cycle Jitter SSCLK (Pin 3)	SSCLK $\geq 133$ MHz, Measured at $V_{DD}/2$	–	85	200	ps
		25 MHz $\leq$ SSCLK $< 133$ MHz, Measured at $V_{DD}/2$	–	215	400	ps
		SSCLK $< 25$ MHz, Measured at $V_{DD}/2$	–	–	1% of $1/SSCLK$	s
$T_{OE1}$	Output Disable Time (pin1 = OE)	Time from falling edge on OE to stopped outputs (Asynchronous)	–	150	350	ns
$T_{OE2}$	Output Enable Time (pin1 = OE)	Time from rising edge on OE to outputs at a valid frequency (Asynchronous)	–	150	350	ns
$T_{LOCK}$	PLL Lock Time	Time for SSCLK to reach valid frequency	–	–	10	ms

## Application Circuit

Figure 2. Application Circuit Diagram

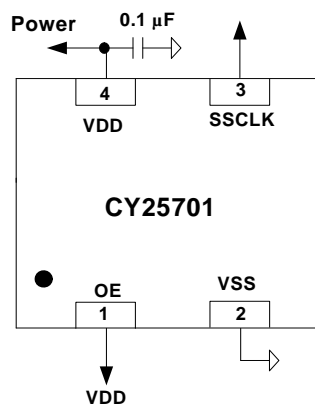

## Switching Waveforms

Figure 3. Duty Cycle Waveform

Duty Cycle Timing ( $DC = t_{1A}/t_{1B}$ )

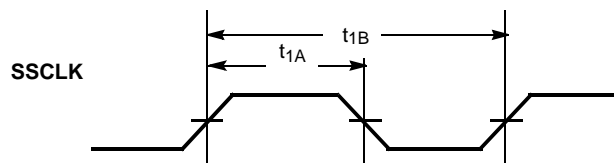

### Notes

- Jitter is configuration dependent. Actual jitter depends upon output frequencies, spread percentage, temperature, and output load. For more information, see the application note, "Jitter in PLL Based Systems: Causes, Effects, and Solutions" available at <http://www.cypress.com/clock/appnotes.html> or contact your local Cypress Field Application Engineer.

Switching Waveforms (continued)

Figure 4. Output Rise/Fall Time Waveform

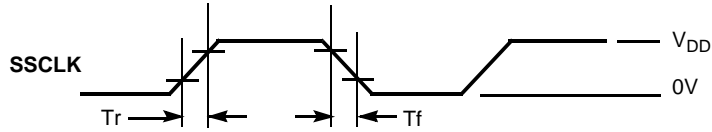

Output Rise time ( $T_r$ ) =  $(0.6 \times V_{DD})/SR1$  (or  $SR3$ )  
 Output Fall time ( $T_f$ ) =  $(0.6 \times V_{DD})/SR2$  (or  $SR4$ )  
 Refer to AC Electrical Characteristics table for SR (Slew Rate) values.

Figure 5. Output Enable/Disable Timing Waveforms

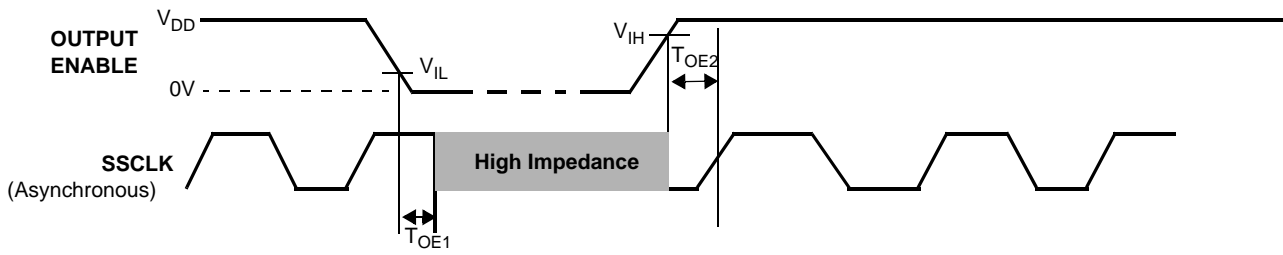

Informational Graphs<sup>[4]</sup>

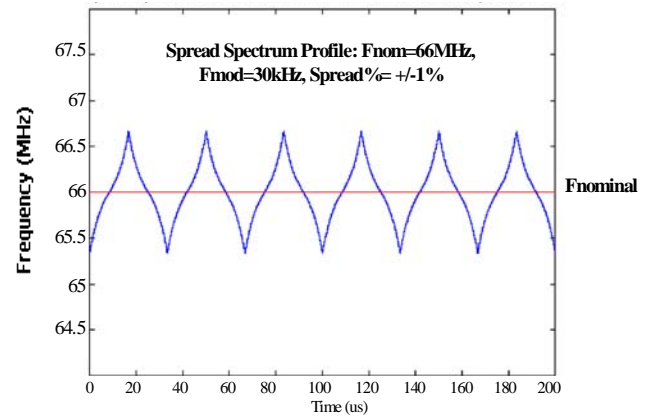
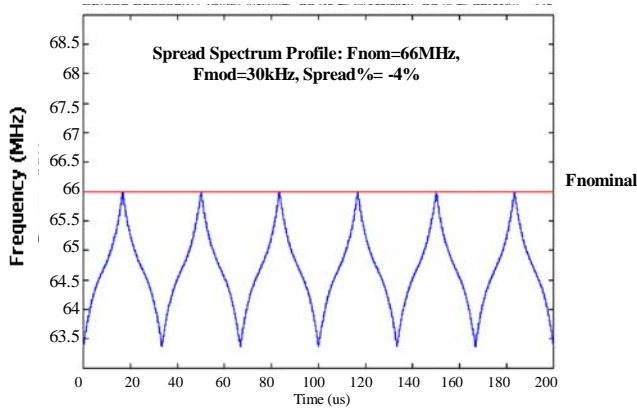
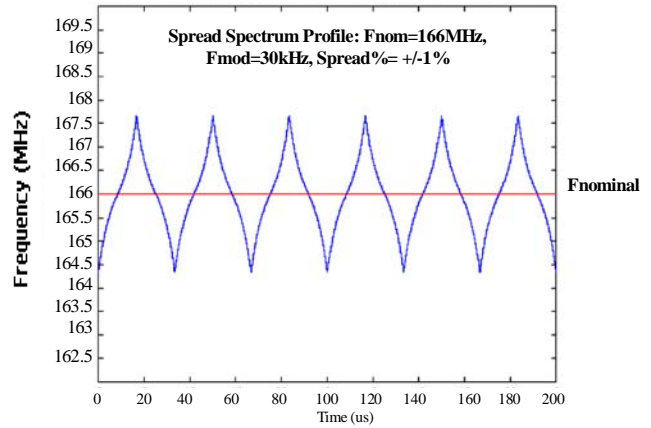
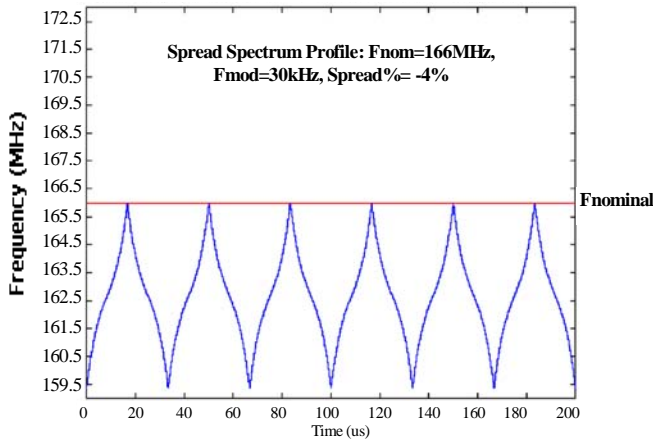

Note

4. The "Informational Graphs" are meant to convey typical performance levels. No performance specifications are implied or guaranteed. Refer to the tables on pages three and four for device specifications.

### Ordering Information

Part Number	Package Description	Product Flow
<b>Pb-Free</b>		
CY25701FLXCT <sup>[5], [8]</sup>	4-Pin Ceramic LCC SMD -Tape and Reel	Commercial, -20° to 70°C
CY25701FLXIT <sup>[5], [8]</sup>	4-Pin Ceramic LCC SMD -Tape and Reel	Industrial, -40° to 85°C
CY25701LXCzzzT <sup>[6], [8]</sup>	4-Pin Ceramic LCC SMD -Tape and Reel	Commercial, -20° to 70°C
CY25701LXlzzzT <sup>[6], [8]</sup>	4-Pin Ceramic LCC SMD -Tape and Reel	Industrial, -40° to 85°C
CY25701KFLXCT <sup>[5]</sup>	4-Pin Ceramic LCC SMD -Tape and Reel	Commercial, -20° to 70°C
CY25701KFLXIT <sup>[5]</sup>	4-Pin Ceramic LCC SMD -Tape and Reel	Industrial, -40° to 85°C
CY25701KLXCzzzT <sup>[6]</sup>	4-Pin Ceramic LCC SMD -Tape and Reel	Commercial, -20° to 70°C
CY25701KLXlzzzT <sup>[6]</sup>	4-Pin Ceramic LCC SMD -Tape and Reel	Industrial, -40° to 85°C

### Actual Marking<sup>[7]</sup>

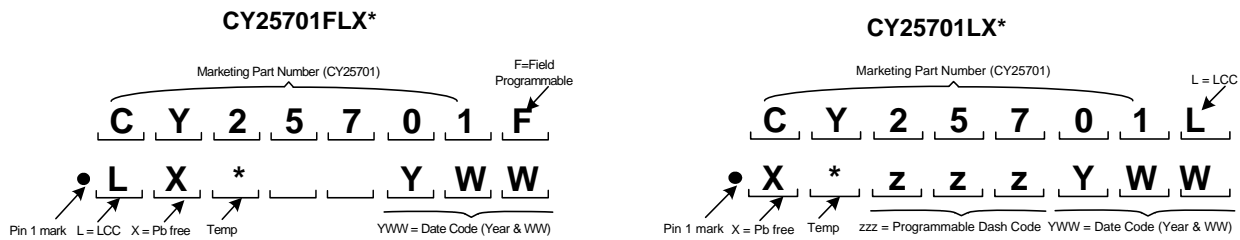

**Notes**

- 5. "FLX" suffix is used for products programmed in the field by Cypress distributors.
- 6. "ZZZ" denotes the assigned product dash number. This number is assigned by the factory after the output frequency and spread percent programming data is received from the customer.
- 7. Temp can be C (Com'l) or I (Industrial).
- 8. Not recommended for new designs.

Package Drawings and Dimensions

Figure 6. 4-Pin (3.2 x 5.0 mm) Ceramic LCC Package Outline

Dimensions in MM  
 General Tolerance:  $\pm 0.15\text{MM}$   
 Kyocera dwg ref: KD-VA5G08  
 Package Weight ~ 0.12 grams

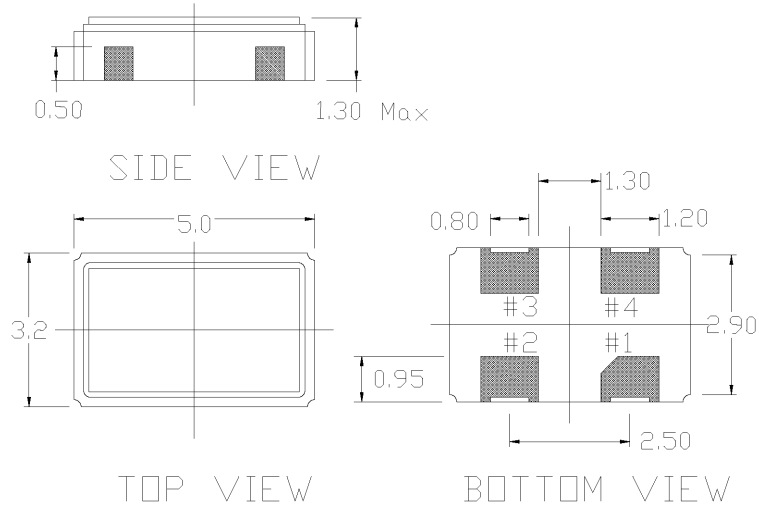

001-02743 \*C



## Document History Page

Document Title: CY25701 Programmable High-frequency Crystal Oscillator with Spread Spectrum(SSXO) and No Spread Spectrum(XO) Option Document Number: 001-07313				
REV.	ECN	Orig. of Change	Submission Date	Description of Change
**	442944	RGL	See ECN	New data sheet
*A	487736	KKV/TMP	See ECN	Added Industrial temp
*B	1414203	DPF/VED	See ECN	Replaced the Package Drawing and Dimension figure on page seven and various copy edits; the reference to the software is now CyberClocksOnline™ rather than CyberClocks software.
*C	2542310	AESA	07/24/08	Updated template. Added Note "Not recommended for new designs." Added part number CY25701KFLXCT, CY25701KFLXIT, CY25701KLXCzzzT, and CY25701KLXlzzzT in <a href="#">Ordering Information</a> on page 7. Added note reference 5 to CY25701KFLXCT and CY25701KFLXIT, and note reference 6 to CY25701KLXCzzzT and CY25701KLXlzzzT.

## Sales, Solutions, and Legal Information

### Worldwide Sales and Design Support

Cypress maintains a worldwide network of offices, solution centers, manufacturer’s representatives, and distributors. To find the office closest to you, visit us at [cypress.com/sales](http://cypress.com/sales).

#### Products

PSoC	<a href="http://psoc.cypress.com">psoc.cypress.com</a>
Clocks & Buffers	<a href="http://clocks.cypress.com">clocks.cypress.com</a>
Wireless	<a href="http://wireless.cypress.com">wireless.cypress.com</a>
Memories	<a href="http://memory.cypress.com">memory.cypress.com</a>
Image Sensors	<a href="http://image.cypress.com">image.cypress.com</a>

#### PSoC Solutions

General	<a href="http://psoc.cypress.com/solutions">psoc.cypress.com/solutions</a>
Low Power/Low Voltage	<a href="http://psoc.cypress.com/low-power">psoc.cypress.com/low-power</a>
Precision Analog	<a href="http://psoc.cypress.com/precision-analog">psoc.cypress.com/precision-analog</a>
LCD Drive	<a href="http://psoc.cypress.com/lcd-drive">psoc.cypress.com/lcd-drive</a>
CAN 2.0b	<a href="http://psoc.cypress.com/can">psoc.cypress.com/can</a>
USB	<a href="http://psoc.cypress.com/usb">psoc.cypress.com/usb</a>

© Cypress Semiconductor Corporation, 2006-2008. The information contained herein is subject to change without notice. Cypress Semiconductor Corporation assumes no responsibility for the use of any circuitry other than circuitry embodied in a Cypress product. Nor does it convey or imply any license under patent or other rights. Cypress products are not warranted nor intended to be used for medical, life support, life saving, critical control or safety applications, unless pursuant to an express written agreement with Cypress. Furthermore, Cypress does not authorize its products for use as critical components in life-support systems where a malfunction or failure may reasonably be expected to result in significant injury to the user. The inclusion of Cypress products in life-support systems application implies that the manufacturer assumes all risk of such use and in doing so indemnifies Cypress against all charges.

Any Source Code (software and/or firmware) is owned by Cypress Semiconductor Corporation (Cypress) and is protected by and subject to worldwide patent protection (United States and foreign), United States copyright laws and international treaty provisions. Cypress hereby grants to licensee a personal, non-exclusive, non-transferable license to copy, use, modify, create derivative works of, and compile the Cypress Source Code and derivative works for the sole purpose of creating custom software and/or firmware in support of licensee product to be used only in conjunction with a Cypress integrated circuit as specified in the applicable agreement. Any reproduction, modification, translation, compilation, or representation of this Source Code except as specified above is prohibited without the express written permission of Cypress.

Disclaimer: CYPRESS MAKES NO WARRANTY OF ANY KIND, EXPRESS OR IMPLIED, WITH REGARD TO THIS MATERIAL, INCLUDING, BUT NOT LIMITED TO, THE IMPLIED WARRANTIES OF MERCHANTABILITY AND FITNESS FOR A PARTICULAR PURPOSE. Cypress reserves the right to make changes without further notice to the materials described herein. Cypress does not assume any liability arising out of the application or use of any product or circuit described herein. Cypress does not authorize its products for use as critical components in life-support systems where a malfunction or failure may reasonably be expected to result in significant injury to the user. The inclusion of Cypress’ product in a life-support systems application implies that the manufacturer assumes all risk of such use and in doing so indemnifies Cypress against all charges.

Use may be limited by and subject to the applicable Cypress software license agreement.